

Scanning Electrochemical Microscopy. 21. Constant-Current Imaging with an Autoswitching Controller

David O. Wipf* and Allen J. Bard*

Department of Chemistry and Biochemistry, The University of Texas at Austin, Austin, Texas 78712

Dennis E. Tallman

Department of Chemistry, North Dakota State University, Fargo, North Dakota 58105-5516

A circuit to perform constant-current imaging over mixed insulator and conductor surfaces with the scanning electrochemical microscope is described. The constant-current servosystem uses the phase information generated by small amplitude modulation of the tip position to automatically determine the surface type and provide proper control of the tip position via a closed-loop feedback process. The constant-current capability is demonstrated by imaging a substrate (Kell-F/Au) containing both electronically conducting and insulating regions.

INTRODUCTION

The scanning electrochemical microscope (SECM) is a scanned probe microscope that is used to examine the surface of materials immersed in electrolyte solution.¹⁻³ In the amperometric feedback mode of the SECM, the probe tip is an ultramicroelectrode that is used to electrogenerate an electroactive species near the surface to be studied. Changes in the electrolysis current as the tip is scanned at a constant height across the surface are used to provide information about the substrate topography and electronic conductivity. The conductivity of a sample can be determined by comparison of the tip current (i_T) when the tip is within a few radii of the surface to that when the tip is far from the surface ($i_{T,\infty}$). The topography is inferred from the change in i_T with tip-substrate distance. Conductive substrates show $i_T > i_{T,\infty}$ (positive feedback) with i_T approximately inversely proportional to distance, and insulating substrates show $i_T < i_{T,\infty}$ (negative feedback) with i_T approximately proportional to distance. In addition to imaging conducting and insulating regions on substrates, the SECM can, because of the chemical specificity supplied by the mediator, image variations in chemical, electrochemical, and enzyme activity at resolutions of 1 μm or better.^{1,4-6}

Most of the reports of SECM imaging have used a constant-height mode in which the tip is rastered across the substrate at a constant reference plane above the sample surface. Images are produced from the current variations as the tip-substrate distance or conductivity changes during scanning. This approach is efficient for relatively large tip electrodes. However, when smaller electrodes are used, scanning in the

constant-height mode becomes more difficult. Because of the requirement that the tip be within a few radii of the surface, the likelihood of a tip crash due to sample height changes or surface tilt greatly increases. This problem can be largely eliminated by use of constant-current imaging. Constant-current imaging, as exemplified by the scanning tunneling microscope,^{7,8} uses a closed-loop electronic and mechanical servosystem to maintain the tip current constant by varying the distance between tip and sample. Images are made by plotting the tip position generated by the servosystem.

Constant-current imaging with the SECM is straightforward when the substrate surface consists of only insulating or only conducting material.⁹ In this case, only the direction of tip movement needs to be specified: an increase in current causes a movement away from the sample for a conductor (as in STM) or toward the sample when it is an insulator. Constant-current imaging over mixed insulating and conducting materials is more difficult and has not been previously described. For a mixed substrate, the servosystem must have information about the type of surface the tip is over. It must also then have two different reference current levels, one for conducting and one for insulating regions, and the ability to switch the polarity of the servo feedback loop to account for the difference in the current-distance characteristics in the two regions. The difficulty has been in determining a priori whether the substrate region under the tip is insulating or conducting. We have shown in a previous paper¹⁰ that this information can be obtained by a variation in the SECM technique, in which a small amplitude modulation of the tip position is combined with the normal SECM technique. A lock-in amplifier is used to demodulate the tip current resulting from the tip-position modulation. The in-phase portion of the modulated current shows improved sensitivity to the surface topography. An important aspect of the tip-position modulation SECM (TPM SECM) experiment is that the phase of the TPM current is different (by 180°) for a conducting or insulating surface. Thus, the TPM phase allows an unambiguous determination of the conductive nature of the surface.

In this paper, we describe a constant-current imaging device for the scanning electrochemical microscope (SECM) that uses an automatically switched servosystem in combination with the TPM signal to image surfaces containing both insulating and electronically conducting regions. Constant-current imaging is demonstrated over a composite poly(chlorotrifluoroethylene)/gold electrode.¹¹⁻¹³ These images are used to provide information about the gold regions and to determine if individual gold regions exposed on the surface

* Present address: Department of Chemistry, Mississippi State University, Mississippi State, MS 39762.

(1) Bard, A. J.; Fan, F.-R.; Pierce, D. T.; Unwin, P. R.; Wipf, D. O.; Zhou, F. *Science* 1991, 254, 68.

(2) Bard, A. J.; Danuault, G.; Lee, C.; Mandler, D.; Wipf, D. O. *Acc. Chem. Res.* 1990, 23, 357.

(3) Engstrom, R. C.; Pharr, C. M. *Anal. Chem.* 1989, 61, 1099A.

(4) Wipf, D. O.; Bard, A. J. *J. Electrochem. Soc.* 1991, 138, L4.

(5) Wipf, D. O.; Bard, A. J. *J. Electrochem. Soc.* 1991, 138, 469.

(6) Pierce, D. T.; Unwin, P. R.; Bard, A. J. *Anal. Chem.* 1992, 64, 1795.

(7) Binnig, G.; Rohrer, H. *Helv. Phys. Acta* 1982, 55, 26.

(8) Park, S.; Quate, C. F. *Rev. Sci. Instrum.* 1987, 58, 2010.

(9) Fan, F.-R.; Bard, A. J., unpublished results.

(10) Wipf, D. O.; Bard, A. J. *Anal. Chem.* 1992, 64, 1362.

(11) Peterson, S. L.; Tallman, D. E. *Anal. Chem.* 1990, 62, 459.

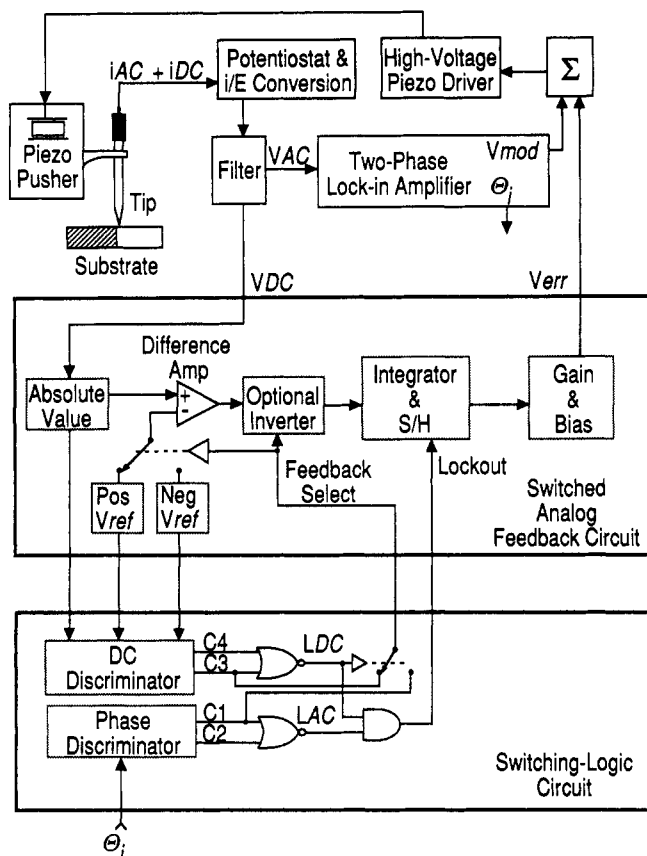

Figure 1. Schematic diagram of the constant-current SECM.

are interconnected to other gold regions.

EXPERIMENTAL SECTION

Reagents. $\text{Ru}(\text{NH}_3)_6\text{Cl}_3$ (Strem Chemicals, Newburyport, MA) was used as received. The electrolyte solution for all experiments was a pH 4.0 phosphate-citrate (McIlvaine) buffer made to 0.5 M ionic strength with KCl.

Electrodes. The ultramicroelectrode tip used was a 1.0- μm radius platinum disk electrode sealed in glass. The tip was prepared as described previously.¹⁰ The substrate was a Kel-F/Au composite electrode. Kel-F, or poly(chlorotrifluoroethylene), is a 3M Co. trade name. The tip electrode was polished with 0.05- μm alumina on felt before each image. A two-electrode configuration was used for all experiments. A silver wire served as a counterelectrode. No external potential control of the Kel-F/Au substrate was used.

AUTOSWITCHING CONSTANT-CURRENT CONTROLLER FOR SECM

A block diagram for the autoswitching feedback controller is shown in Figure 1. The basic SECM apparatus that performs the raster motion of the tip and data acquisition is not shown here, but it has been described in previous publications.^{5,10} To the basic SECM is added instrumentation to perform the tip-position modulation experiment, a switched analog feedback circuit, and a switching-logic circuit to determine the type of feedback control used. The tip-position modulation (TPM) experiment has also been described.¹⁰ Here we apply a small amplitude (typically 0.1 tip radius) modulation of the tip position normal to the sample surface. A two-phase lock-in amplifier is used to determine the phase of the modulated tip current resulting from the tip modulation. Because a movement of the tip away from the surface causes

an increase in current over an insulating substrate and a decrease in current over an electronically conducting substrate, the phase of the tip current is different by 180° over these two substrates. This change in phase allows an unambiguous determination of the surface type.

The analog feedback circuit is similar to that reported for STM experiments.^{7,8} In effect, it provides an amplified and filtered voltage (V_{err}) that is proportional to the difference between the desired constant-current level and the measured direct current. Note here that the constant-current level and the dc tip current are converted to voltages. V_{err} is used to drive a piezoelectric tip positioner so as to maintain the desired current level. The voltage applied to the tip positioner is a map of the vertical tip motion made to maintain that constant current and provides the image signal.

A major difference in the circuit shown in Figure 1 from STM-type controllers is the ability to electronically switch the polarity of V_{err} and the reference current (voltage) level. It is necessary to switch the reference levels with change in surface type, since the dc tip current over an insulator is smaller than the background level ($i_{T,\infty}$) and the dc tip current over a conductor is greater than $i_{T,\infty}$. The polarity of V_{err} must also be switched, since the tip current-distance behavior over insulating and conducting substrates is opposite in sign. Another difference is the ability to arrest the feedback process. Because it is impossible to determine the proper feedback response as the tip scans over an insulating/conducting boundary, the tip-positioning signal is arrested (locked out) by a sample and hold circuit until the boundary region is passed.

The switching-logic circuit controls the feedback-type switches and determines when to hold (lockout) the V_{err} signal. To make these decisions, we have found that two separate discriminators are required. The phase discriminator (a dual window discriminator) uses the phase information from the lock-in amplifier to determine if the phase is in a range appropriate for a conducting sample (C1 Hi) or for an insulating sample (C2 Hi) or if the phase value is intermediate and thus indeterminate (C1 and C2 Lo). The phase information is generally most accurate when the tip is not near a boundary. Near boundaries, the phase information tends to oscillate between the two decisions. For this reason a dc level discriminator is used to help make decisions at the boundary region. The dc discriminator provides an override function for the switching logic. If the tip current is larger than the constant-current level for the conducting surface (Pos V_{ref}) C3 is set Hi, and if the tip current is less than the constant-current level for the insulating surface (Neg V_{ref}) C4 is set Hi. If C3 or C4 is Hi, this is an indication that the tip has approached closer than expected to the conducting or insulating surface. Emergency action is thus provided to prevent tip crashes.

The switching decisions are straightforward once the phase and dc discriminator outputs are available. Figure 2 is a schematic depiction of the discriminator action and decisions for a scan over insulating and conducting regions. If C1, C2, C3, and C4 are all Lo, then no decision on the feedback type can be made, and the lockout signal is set Hi to hold the V_{err} signal. If any one of these are Hi, then the lockout signal is set Lo, and the appropriate feedback type is selected. Note that C1 and C2 cannot be Hi simultaneously, neither can C3 and C4. Conflicting decisions from the phase and dc discriminator (e.g., C1 and C4 Hi) are always resolved in favor of the dc decision.

As represented in Figure 2, the piezo voltage does not exactly track the surface topography, because the Pos and Neg V_{ref} levels can be set to represent different effective tip heights over conducting and insulating regions. Moreover, there is always an artifact at the boundary between the two regions, mainly because the tip can sense parts of the substrate that

(12) Peterson, S. L.; Weisshaar, D. E.; Tallman, D. E.; Schulze, R. K.; Evans, J. F.; DesJarlais, S. E.; Engstrom, R. C. *Anal. Chem.* 1988, 60, 2385.

(13) Peterson, S. L.; Tallman, D. E. *Anal. Chem.* 1988, 60, 82.

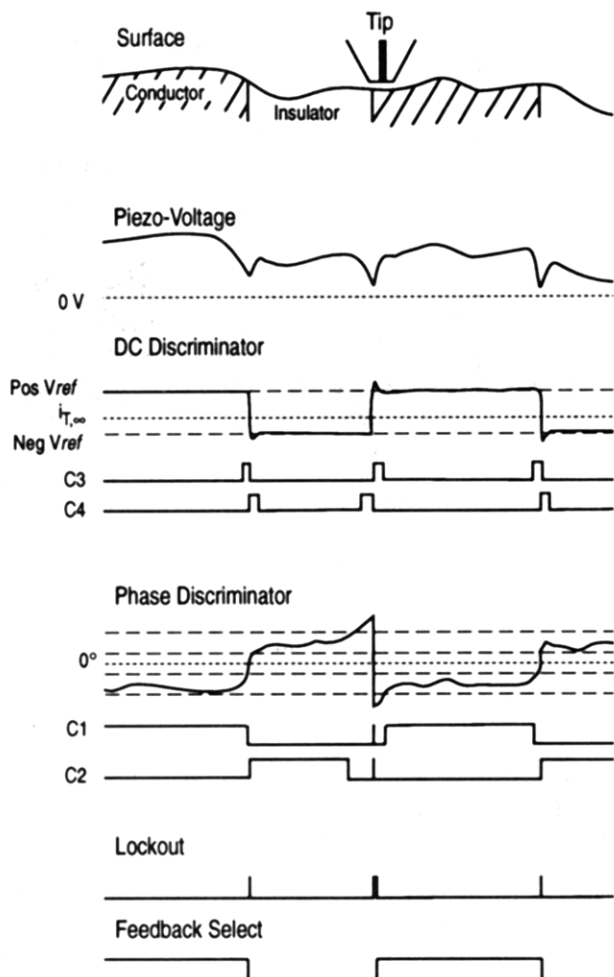

Figure 2. Schematic timing diagram of the operation of the phase and dc discriminator circuits as the tip is scanned over a surface with insulating and conducting regions.

are not immediately under it. Therefore, as the tip scans from a conducting to an insulating region, a decrease in tip current occurs because of the nearby insulator. In the constant-current mode, the servosystem compensates by moving the tip closer to the surface. As the tip scans from an insulating to a conducting region, the current increases due to the nearby conductor. Again the controller attempts to compensate for this effect by moving the tip closer to the surface. In either event, the tip moves closer to the surface. The artifact does serve a useful purpose in that it provides a clear demarcation of the boundaries of the two regions.

CONSTANT-CURRENT IMAGING OF A COMPOSITE POLY-(CHLOROTRIFLUOROETHYLENE)/GOLD ELECTRODE

Kel-F/Gold Electrode. The constant-current imaging mode of the SECM was used to scan the surface of a poly-(chlorotrifluoroethylene) (referred to further as Kel-F, a 3M Co. trade name for the polymer) and gold composite electrode. These Kel-F/Au composite electrodes were first described by Tallman and co-workers as a unique type of microelectrode ensemble.¹¹⁻¹⁴ The composite electrodes show high conductivity with a low metal content, with a weight and cost reduction that make them attractive electrodes for amperometric detectors and conceivably for energy storage and generation.¹¹⁻¹⁴ An optical micrograph of the Kel-F electrode used in this work is shown in Figure 3. This electrode contains 14% Au by volume and was made by compression molding

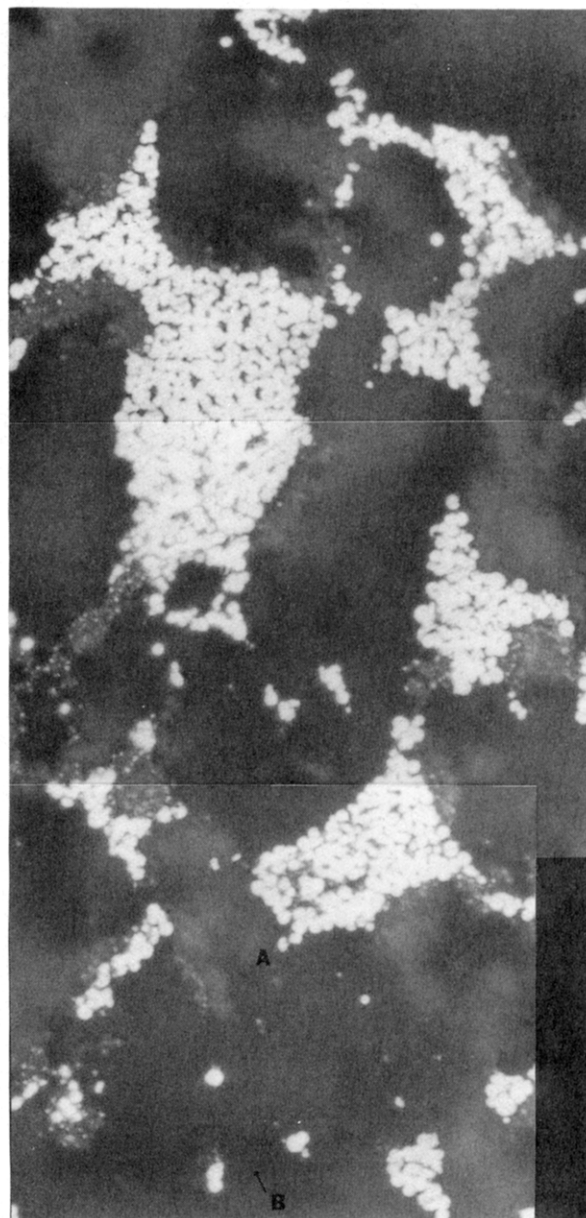

Figure 3. Composite optical micrograph of the surface of the Kel-F/Au electrode. The area shown is approximately $100\ \mu\text{m} \times 200\ \mu\text{m}$.

of a Kel-F and gold particle mixture. The gold particles used for this electrode are spherical and have an average size in the range of $0.5\text{--}2.0\ \mu\text{m}$.¹¹ Individual particles are readily observed in the micrograph. Most of the particles, however, are agglomerated into larger "islands", a consequence of the forced segregation of conductor particles which occurs during fabrication of these composite materials.¹¹⁻¹⁴ The Kel-F is transparent so that the optical micrograph shows gold clusters below the surface of the polymer.

An interesting aspect of this composite electrode is its high conductivity. The 14% gold composite has a reported bulk conductivity of only 100 times less than pure gold. This high conductivity suggests that the particles form a conducting network of agglomerated particles rather than a uniform dispersion throughout the Kel-F matrix.

Constant-Current Image of the Kel-F/Au Electrode. Figures 4 and 5 show the images of the Kel-F/Au electrode, over the identical region shown in the micrograph in Figure 3, obtained with the SECM in the constant-current mode. These images were made with a $2\text{-}\mu\text{m}$ diameter Pt tip electrode using a $2.1\ \text{mM}$ solution of $\text{Ru}(\text{NH}_3)_6^{3+}$ in a pH 4.0 buffer as the mediator species. The tip position was modulated at a frequency of 160 Hz with a 100-nm pp (peak to peak)

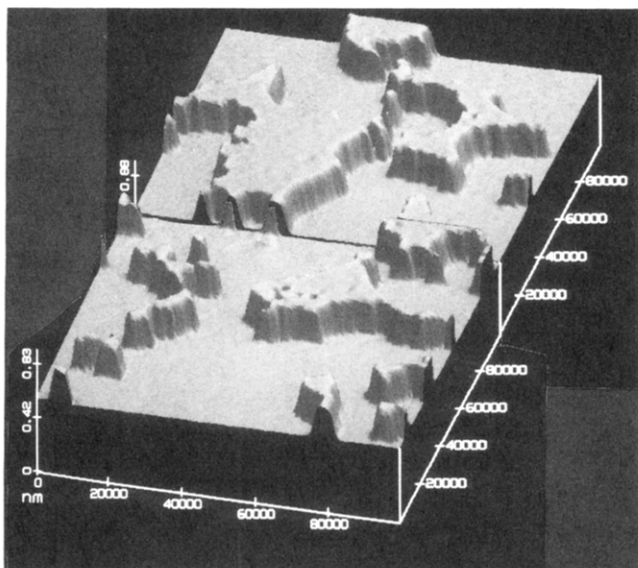

Figure 4. Surface plot of the tip current recorded during a constant-current image scan. The image shown is a composite of two consecutive scans. Scan size is $100\ \mu\text{m} \times 200\ \mu\text{m}$. Vertical axis is current (in nA). Imaging conditions are given in the text.

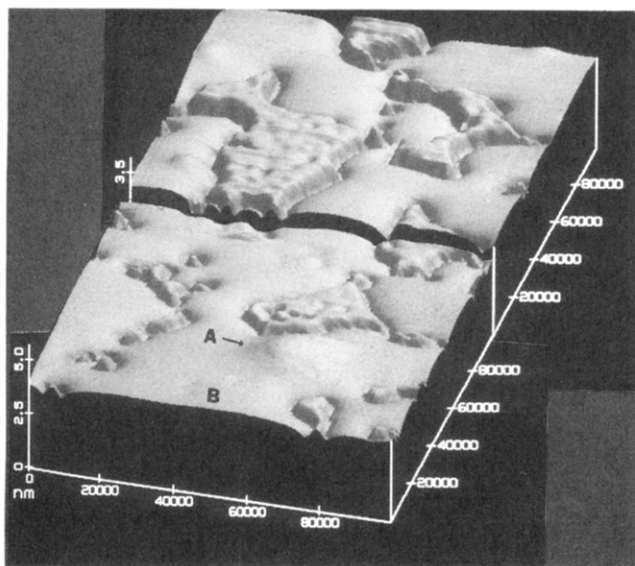

Figure 5. Surface plot of the Z-piezo positioner voltage recorded during a constant-current image scan. The image shown is a composite of two consecutive scans. Scan size is $100\ \mu\text{m} \times 200\ \mu\text{m}$. Vertical axis is relative tip position (in μm) obtained from the piezo voltage. Imaging conditions are given in the text.

modulation amplitude. The tip raster scan rate was $10\ \mu\text{m}/\text{s}$, and the total scan area for each image was $100\ \mu\text{m} \times 100\ \mu\text{m}$. (Note that Figures 4 and 5 are composites of two separate scans.) The negative and positive current reference levels were set at 500 and 780 pA, respectively, and $i_{T,\infty}$ was 680 pA, implying maintenance of about a $2\text{-}\mu\text{m}$ tip-substrate spacing over both conductive and insulating regions. A constant-height image of a portion of the Kel-F/Au surface is shown in Figure 6 for comparison to the constant-current images in Figures 4 and 5. Imaging conditions for Figure 6 were identical to those for Figures 4 and 5 with the exception that the feedback servosystem was disabled.

The tip current observed during the imaging scan is shown in Figure 4. This illustrates the automatic current level switching that occurs as the tip scans over either conducting (high plateau) or insulating (low plane) regions on the electrode surface. The flat currents at the plateaus and basins indicate that the circuit maintains good control over the current for both conducting and insulating regions. As seen,

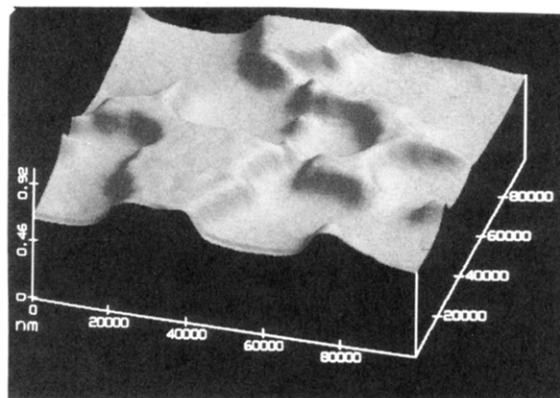

Figure 6. Surface plot of the tip current recorded during a constant-height scan. Scan size is $100\ \mu\text{m} \times 100\ \mu\text{m}$. Vertical axis is relative tip position (in μm). Imaging conditions are given in the text.

the current shows occasional fluctuations. The current change near the conducting/insulating boundaries is expected as the circuit switches current levels. The feedback circuit is also not able to track the surface under conditions where either an insulating or a conducting region of approximately the tip dimension is embedded in a larger conducting or insulating zone. In this case, the circuit cannot decide on the surface type and a lockout condition is entered. This allows the tip current to fluctuate slightly. This is less of a difficulty under conditions where the tip is much larger than the embedded insulating or conducting region. For this circumstance, the decision circuit continues to indicate that the surface was that of the surrounding material and the change in tip current caused by the small embedded region is compensated by a tip-position adjustment. Thus, a small region would be masked [as would also be the case in current imaging (constant height) SEM].

Figure 5 is the image of the voltage on the Z-piezo positioner. The voltage scale was converted to a relative distance scale by multiplying by the piezo positioner extension factor (i.e., $5\ \text{nm}/\text{V}$). Thus, this image shows the topography of the sample, although the switching artifacts (discussed above) generate false topographic features at the boundary between the insulating and conducting regions. By comparing this image with the current image (Figure 4) the insulating and conducting regions are readily distinguished. Because the conductive regions are not continuous but are an agglomeration of conducting Au particles with interspersed insulating regions, these regions show an apparent roughness.

Another important aspect of the imaging process is that the tip-substrate distance during the constant-current scan can be adjusted to the desired height by adjustment of the tip current reference levels on the feedback controller. Since the adjustment for conducting and insulating levels (i.e., Pos and Neg V_{ref}) are independent of each other, the tip-substrate distance will be, in general, different over conducting and insulating regions. The relative tip heights over the two regions could be adjusted to absolute distance by postprocessing of the scan images.

The constant-height image, Figure 6, can be compared to the upper half of the constant-current image in Figure 5, since both are images of the same electrode region. The constant-height image does not show as much detail as the constant-current image, nor does it provide as accurate an impression of the true topography of the sample. The improvement in resolution at the constant-current image can be attributed in part to the ability of the tip to track the surface, thus allowing closer tip-substrate separations and consequently higher resolution. Also, the artifacts caused by the feedback switching process help to delineate the boundaries of the insulating conducting regions. The poorer

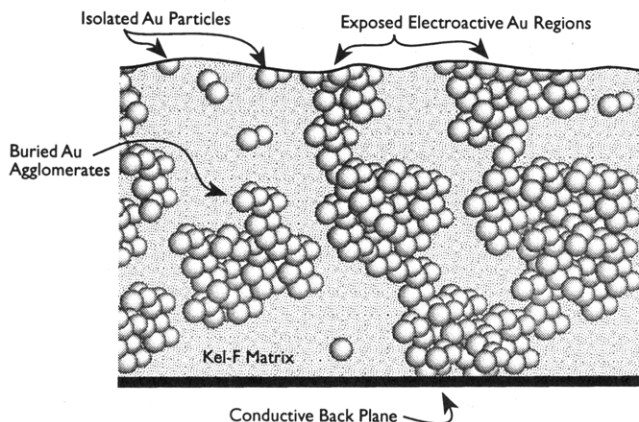

Figure 7. Schematic representation of structure of Kel-F/Au electrode.

topographic representation of the constant-height mode is due to the nonlinear relation between tip current and distance, although postprocessing using the known $i_T - d$ relations¹ could again be used to obtain a truer topographic image. The linear response provided by the constant-current mode greatly improves the image. For example, the "bumps" on the insulator appear on the left-hand side of the constant-current image. These features, which appear as shallow depressions in Figure 6, are barely observed on the constant-height image. Note, however, that the sensitivity of constant-height images can be greatly improved by use of the TPM SECM technique.¹⁰

Conductivity of the Kel-F/Au Surface. Comparison of the optical micrographs and the SECM images shows several differences. Although the SECM indicates a large raised bump about 1.5 μm high on the insulating region (A, lower right of Figure 5), a corresponding bump cannot be seen in the optical image (Figure 3) probably because it is difficult to observe such features optically on the transparent Kel-F. A more intriguing difference is the lack of a conductive response for several apparently exposed Au regions. The bottom middle portion of the optical micrograph shows three small Au regions in a triangular formation, B. Each of the regions is about 2–4 μm in diameter. Close inspection of the constant-current image reveals only shallow dimples in the insulating region to mark the location of the small Au regions. Other similar areas also exist on the micrographs. A possible explanation for these differences is that the Au particles seen optically are covered by a thin transparent film of Kel-F, perhaps generated by the polishing procedure.¹² The observed features would require that the particles be recessed beneath the surface.

A more likely explanation is that these Au particles are indeed exposed and conductive but are not connected to and, thus, are electrically isolated from the remainder of the agglomerated gold particle network (see Figure 7). The Kel-F/Au electrode was not potentiostated during these images. It has been demonstrated that, at sufficiently large substrates, the rest potential of the substrate electrode, developed by the oxidized mediator species, is sufficient to cause the diffusion-limited recycling of the tip-generated, reduced mediator.⁵ Thus, a conductive substrate is self-biased by the mediator, and external potential control is unnecessary for simple imaging experiments. However, at small substrate areas, the current required to reoxidize the tip-reduced species becomes large enough to shift the potential in these areas away from the solution rest potential (in a negative direction for a solution initially containing the oxidized form of the mediator). At a substrate-to-tip area ratio of less than 100

this effect becomes important, and diffusion-limited recycling of the mediator is no longer possible because of the shift in potential. This causes the tip current to be smaller than would otherwise be observed at a conducting region, although the current remains larger than that of an insulating substrate. Alternatively, if the substrate is externally biased and the small regions are connected to the electrode contact (back plane) (Figure 7), the tip current will be nearly unchanged at substrate-to-tip ratios of 1.¹⁵

On the basis of this argument, we suggest that the Au particles seen optically, but not by SECM, are electrically isolated from the neighboring Au agglomerate networks. Nonisolated particles would behave like externally biased, small substrates and would show the normal conducting response. The small, dimple-like features on the constant-current image are a consequence of the tiny positive feedback currents expected at conducting particles. Since the servo-system controller is in the insulating-type feedback mode over this region, the increase in current over the particles would cause the servocontroller to move the tip closer to the surface and generate the dimples. Finally, the results suggest a model for the Kel-F/Au composite electrode that agrees with the previous consolidated composite model¹¹ such as that shown schematically in Figure 7. The gold must remain largely agglomerated during the molding with the Kel-F to produce the conductive surface regions, since the relative volume fraction of Au particles is smaller than that needed for continuous structure formation (i.e., ≥ 0.15 for 3D percolation¹⁶) when dispersed and randomly distributed throughout the insulator.

CONCLUSIONS

The autoswitching servosystem described here is the first demonstration of constant-current scanning with the SECM over mixed insulating and conducting substrates. By including phase information generated by modulating the tip position, the type of substrate surface the tip is over can be automatically determined, allowing proper control of the tip position using a closed-loop feedback process. The circuit described uses a lock-in amplifier for phase-sensitive detection, discrete analog circuits for the servocontroller and discrete digital logic to make the switching decision. A more general purpose device could be constructed using digital signal processors to provide the tip-position control, although the basic decision principles embodied in the circuit shown would likely continue to be used.

The ability of the autoswitching circuit was demonstrated by imaging a mixed insulating/conducting surface, the Kel-F/Au electrode. In addition to accurately tracking the surface whether insulating or conducting, the image also revealed the presence of conducting, yet electrically isolated, Au particles on the electrode surface. The constant-current image also showed better resolution of insulating/conducting boundaries and provided a more accurate topographic map of the surface. This type of switching circuit will be especially useful for SECM imaging with smaller tips. As described in the introduction, the constant-height mode becomes difficult as the tip size decreases since the possibility of a tip crash greatly increases. For example, an SECM tip would almost certainly crash if it encountered a small insulating region on the surface. The autoswitching circuit, with further refinements, should reduce the chance of a crash under these circumstances.

ACKNOWLEDGMENT

The support of this research by the Robert A. Welch Foundation is gratefully acknowledged.

(15) Bard, A. J.; Mirkin, M. V.; Unwin, P. R.; Wipf, D. O. *J. Phys. Chem.* 1992, 96, 1861.

(16) Clark, P. S.; Orton, J. W.; Guest, A. J. *Phys. Rev. B* 1978, 18, 1814.